

PARTYTÄLT PARTYTELT JUHLATELTTA PARTYTELT

3 x 6 m

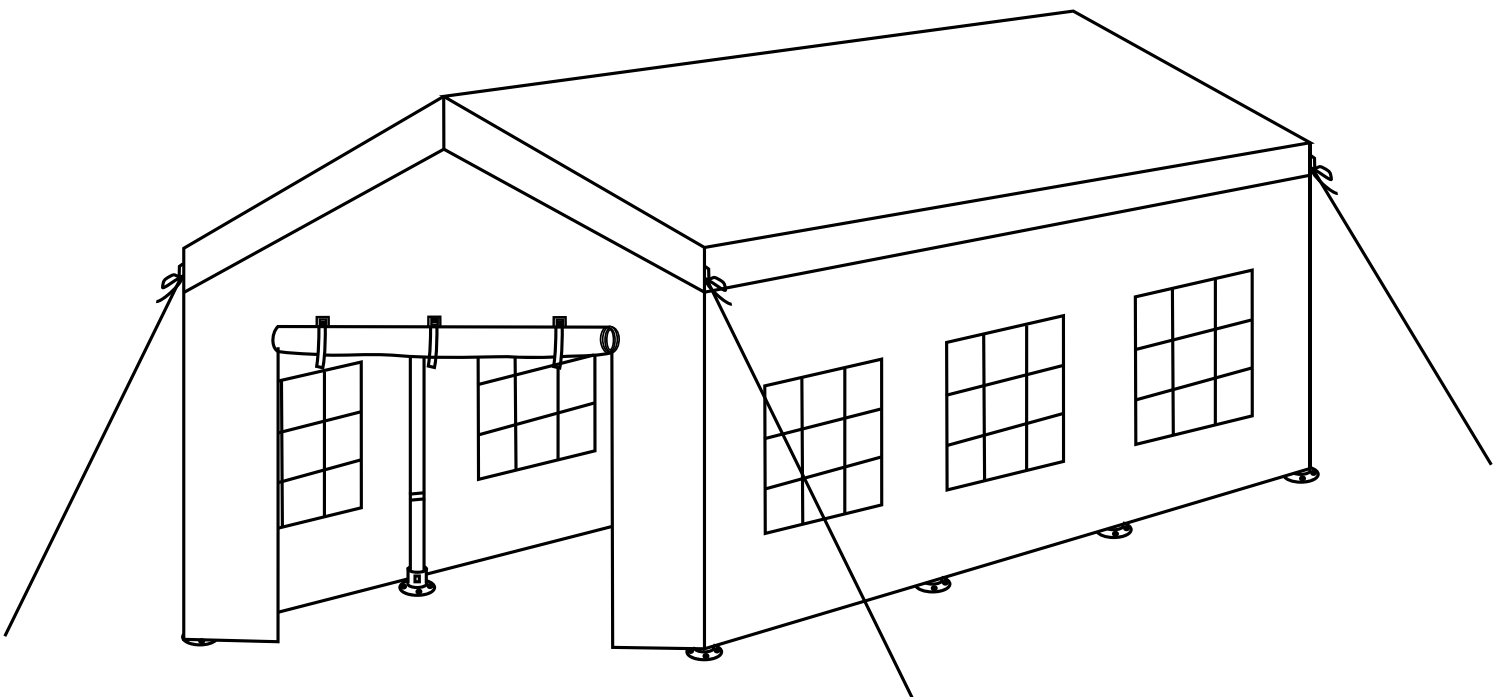

PARTYTÄLT 3 X 6 m

Läs igenom instruktionerna nedan och följ dem noga. Förvara dem för framtida bruk.

Minst två personer krävs för att montera partytältet.











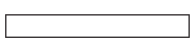

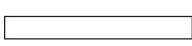

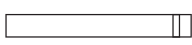
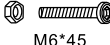
OBS! Barn ska inte vara i närheten medan tältet monteras. Förvara tältdelarna utom räckhåll för barn.

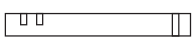
ADVARSSEL!

- Tag teltet ned, før det begynder at blæse for meget.
- Lav aldrig åben ild i eller i nærheden af teltet.
- Eventuel sne, som samles på tagdugen, skal hurtigst muligt fjernes.

UNDERHÅLL OCH FÖRVARING

- Partytältet är i första hand ämnat att skydda mot solens strålar, inte mot hård blåst och regn. Takväven med PVC-skikt är vattenavvisande men inte vattentät. För att materialet inte ska åldras i förtid, se till att alltid ta bort regnvatten som samlats på väven.
- Rengör takväven med ett svagt rengöringsmedel och låt det sedan torka helt. OBS! Använd aldrig lösningsmedel, då detta kan bleka och skada materialet, och inte heller basiska eller sura rengöringsmedel. Rengör inte väven med högtryckstvätt!
- Innan tältet tas in till förvaring ska takväven vara helt ren och torr. Vik ihop det utmed sömmarna. Stolpar och markpinnar ska inte packas tillsammans med väven.
- Förvara takväven på torr och väl ventilerad plats.

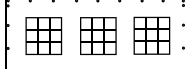
| | | | | | | | | |
|---|---|------|---|--|-------|---|---|------|
| ① |  | 8pcs | Ⓒ |  | 8pcs | Ⓖ |  | 1pc |
| ② |  | 9pcs | ⒫ |  M6*10 | 42pcs | Ⓕ |  | 1pc |
| ③ |  | 4pcs | ⒫ |  M6*45 | 8pcs | Ⓖ |  | 1pc |
| ④ |  | 4pcs | Ⓓ |  | 50pcs | Ⓖ |  | 1pc |
| Ⓐ |  | 6pcs | Ⓔ |  | 4pcs | Ⓖ |  | 1pc |
| Ⓑ |  | 6pcs | Ⓕ |  | 20pcs | Ⓖ |  | 2pcs |

STEP 1

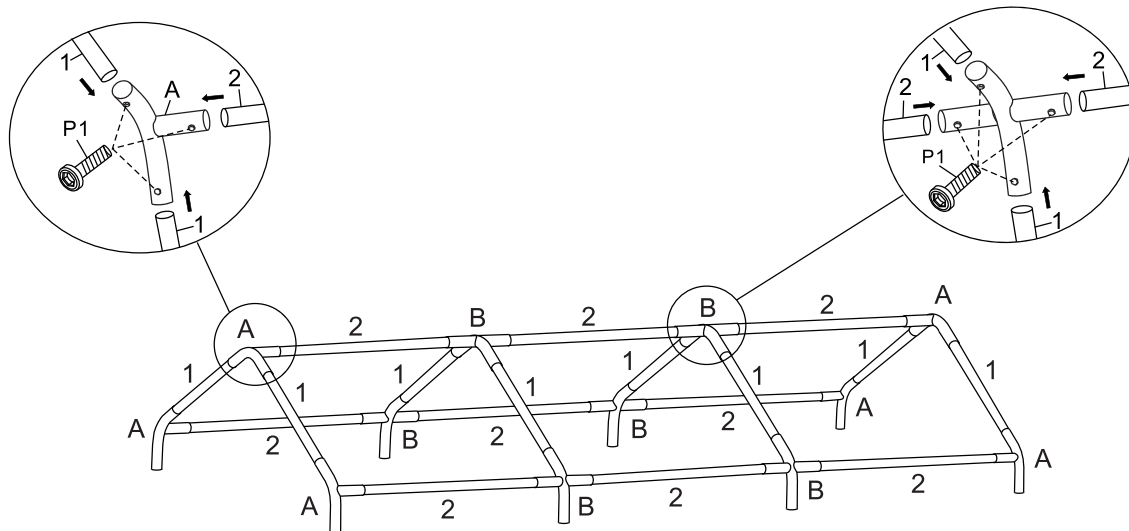

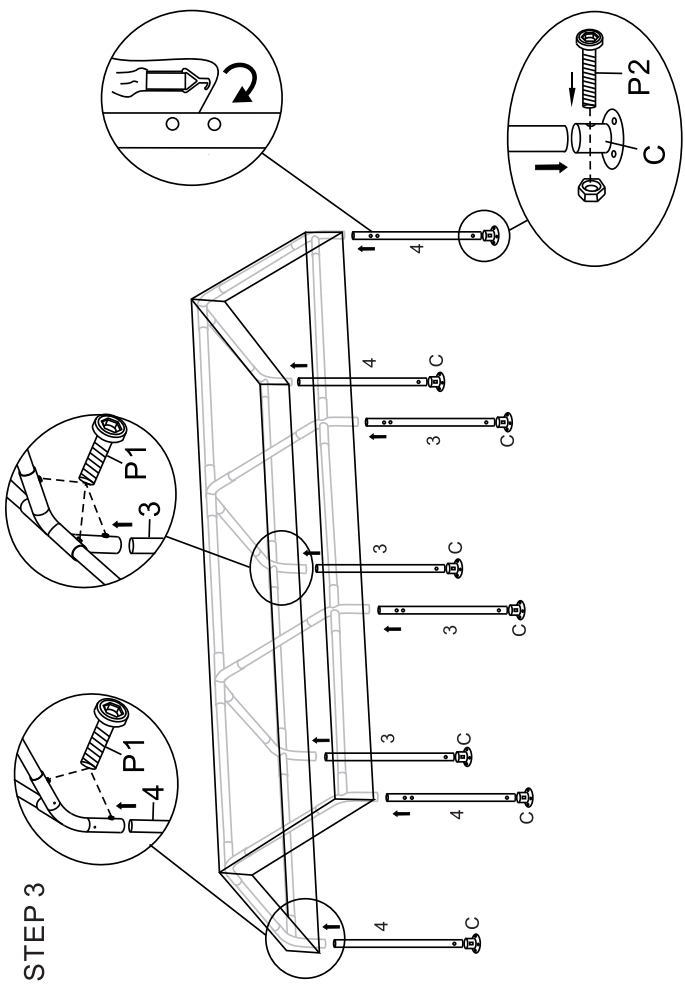

STEP 3

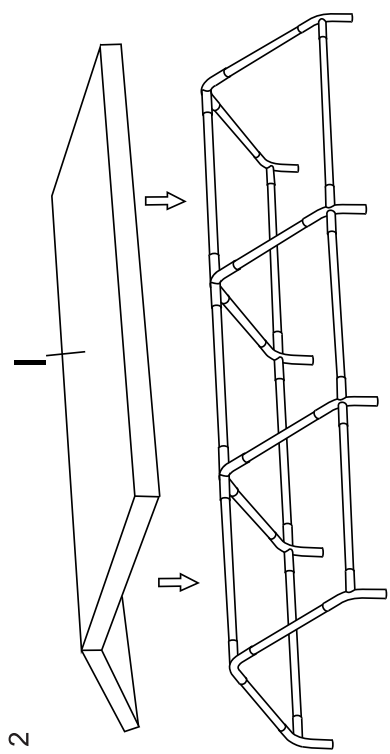

STEP 2

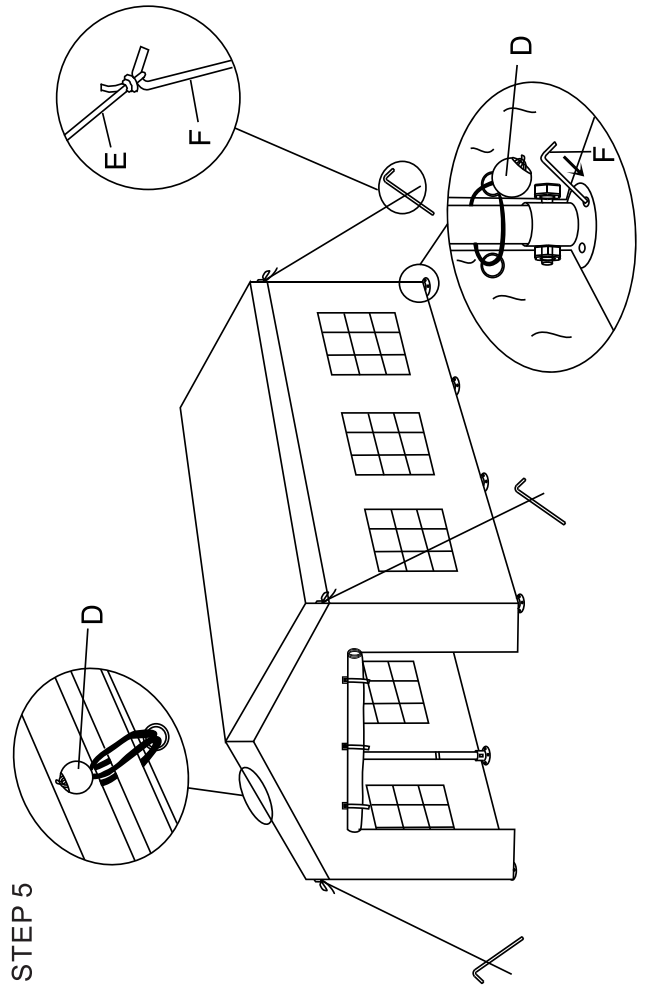

STEP 5

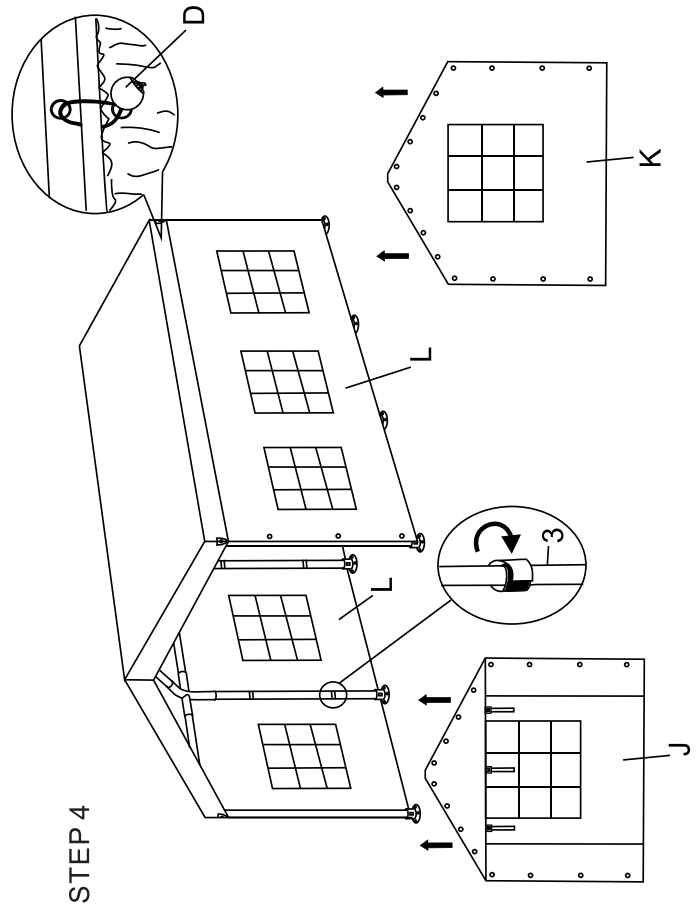

STEP 4

PARTYTELT 3 X 6 m

Les instruksjonene nedenfor, og følg dem nøye. Oppbevar dem for fremtidig bruk.

Det må minst være to personer for å montere partyteltet.











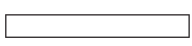

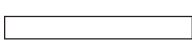

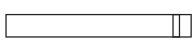
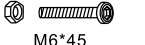
OBS! Barn må ikke være i nærheten mens teltet monteres. Oppbevar delene til teltet utilgjengelig for barn.

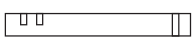
ADVARSEL!

- Ta ned teltet før det begynner å blåse for mye.
- La det aldri brenne åpen flamme i eller i nærheten av teltet.
- Eventuell snø som har samlet seg på duken, må fjernes så snart som mulig.

VEDLIKEHOLD OG OPPBEVARING

- Partyteltet er først og fremst ment å beskytte mot solens stråler, ikke mot sterk vind og regn. Takduken med et PVC-lag er vannavstøtende, men ikke vanntett. For at duken ikke skal eldes før tiden, må man passe på alltid å fjerne regnvann som har samlet seg på duken.
- Rengjør takduken med et mildt rengjøringsmiddel, og la den deretter tørke helt. **OBS!** Ikke bruk løsemidler da dette kan bleke og skade duken, og heller ikke basiske eller sure rengjøringsmidler. Ikke rengjør duken med høytrykksvasker!
- Før teltet tas inn til oppbevaring, skal takduken være helt ren og tørr. Brett den sammen i sømmene. Stolper og plugger skal ikke pakkes sammen med duken.
- Oppbevar takduken på et tørt og godt ventilert sted.

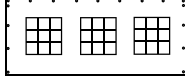
| | | | | | | | | |
|---|---|------|---|--|-------|---|---|------|
| ① |  | 8pcs | Ⓒ |  | 8pcs | Ⓖ |  | 1pc |
| ② |  | 9pcs | ⒫ |  M6*10 | 42pcs | Ⓕ |  | 1pc |
| ③ |  | 4pcs | ⒫ |  M6*45 | 8pcs | Ⓖ |  | 1pc |
| ④ |  | 4pcs | Ⓓ |  | 50pcs | Ⓖ |  | 1pc |
| Ⓐ |  | 6pcs | Ⓔ |  | 4pcs | Ⓖ |  | 1pc |
| Ⓑ |  | 6pcs | Ⓕ |  | 20pcs | Ⓖ |  | 2pcs |

STEP 1

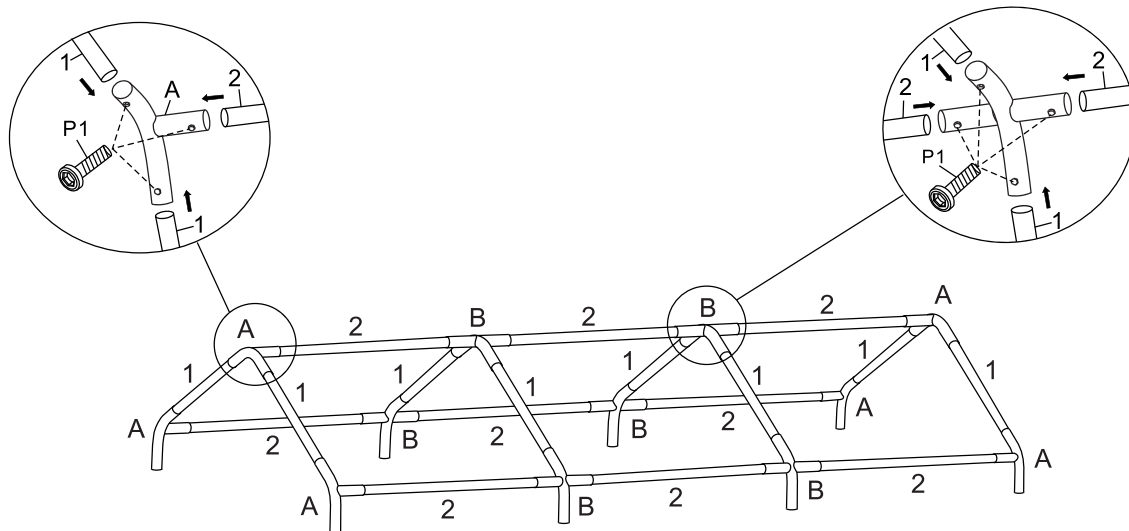

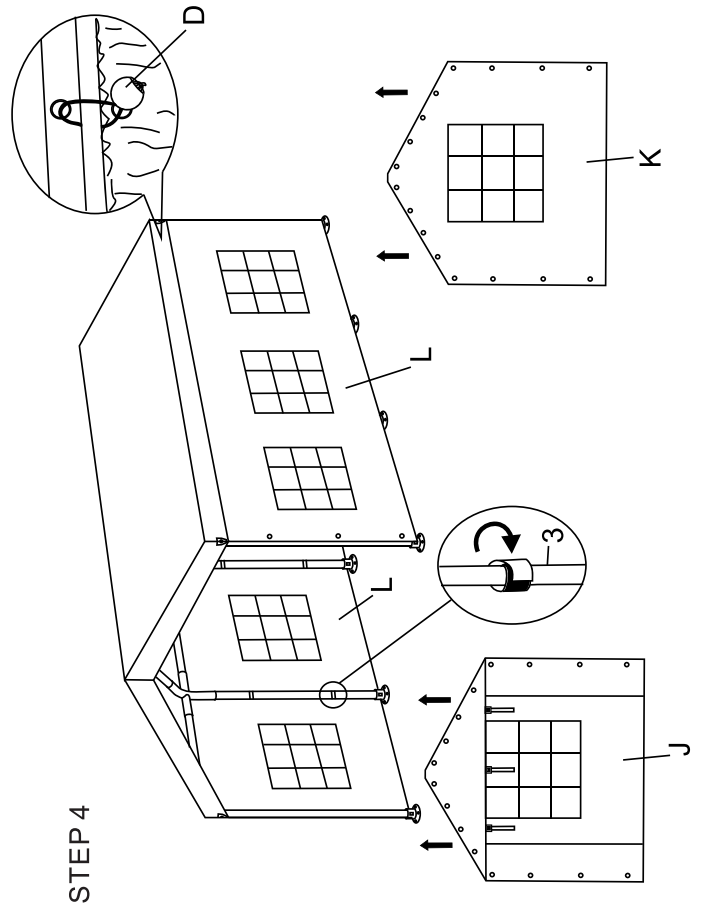
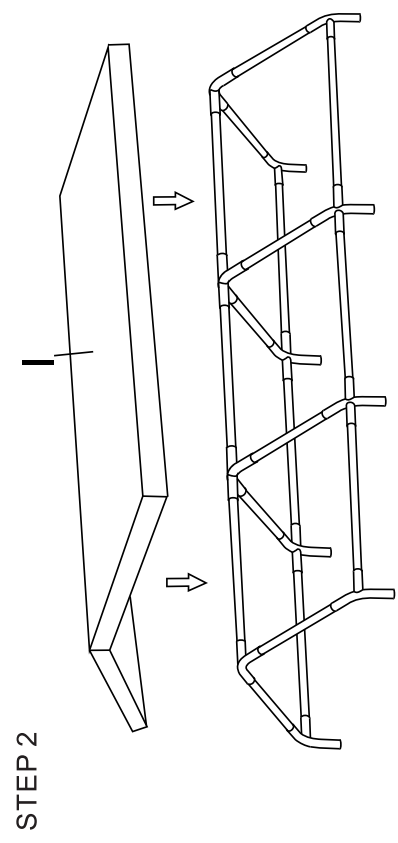
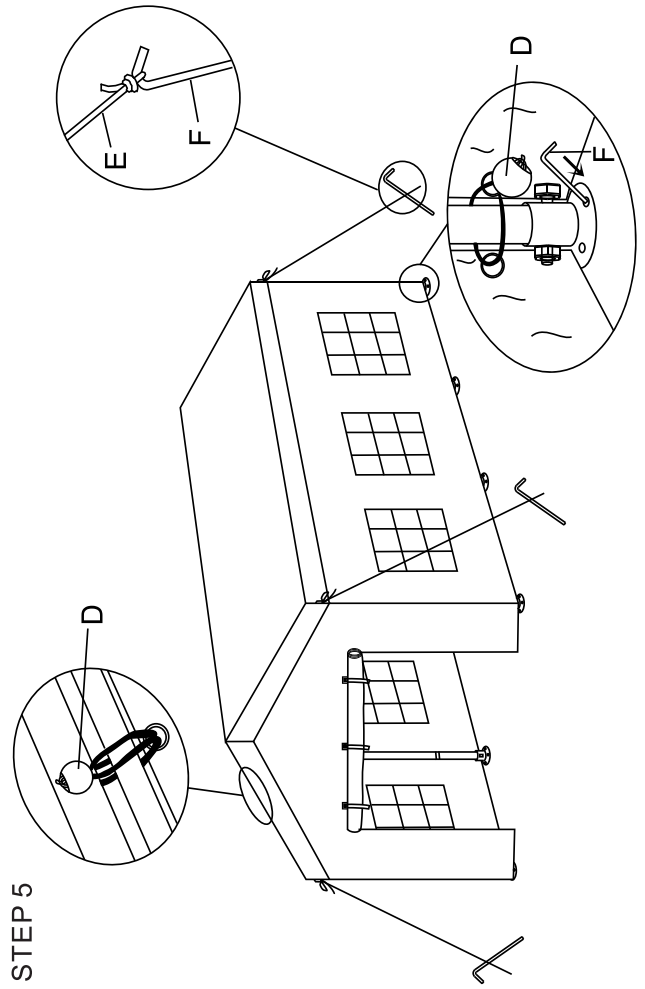
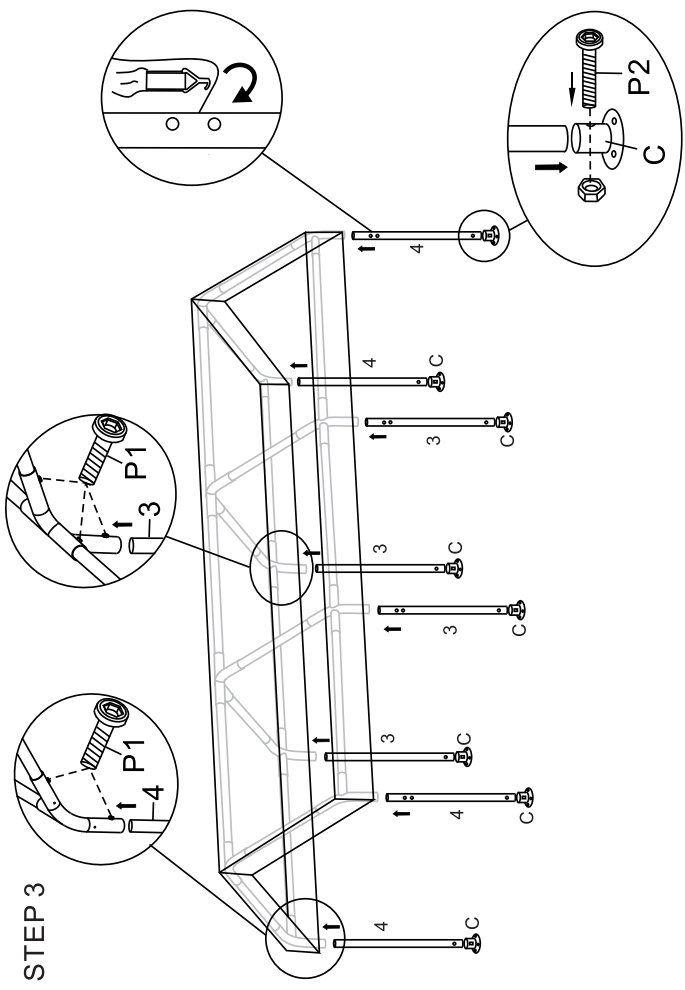

JUHLATELTTA 3 X 6 m

Lue käyttöohjeet ja noudata niitä huolellisesti. Säilytä ohjeet tulevaa käyttöä varten.

Juhlateltan pystyttäminen edellyttää vähintään kahta henkilöä.











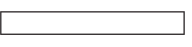

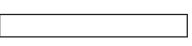

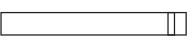
HUOM! Kun telttaa pystytetään, lähellä ei saa olla lapsia. Säilytä teltan osat lasten ulottumattomissa.

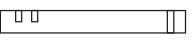
VAROITUS!

- Pura teltta ennen kuin tuuli yltyy liian voimakkaaksi.
- Älä koskaan tee avotulta teltassa tai sen lähetyvillä.
- Kankaan päälle mahdollisesti kertynyt lumi on poistettava heti.

KUNNOSSAPITÄMINEN JA SÄILYTTÄMINEN

- Juhlateltan tehtävä on ensisijaisesti suojata auringonpisteeltä, ei sateelta tai voimakkaalta tuulelta. Telttakankaan PVC-kerros hylkii vettä, mutta se ei ole vesitiivis. Jotta materiaali ei vanhennu enneaikaisesti, kankaan päälle kertynyt sadevesi on poistettava.
- Puhdista telttakangas miedolla puhdistusaineella, ja sen katon kuivua kokonaan. **HUOM!** Älä käytä liuottimia, sillä ne voivat vaurioittaa materiaalia. Sama koskee emäksisiä tai happamia puhdistusaineita. Älä puhdista kangasta painepesurilla!
- Ennen teltan purkamista ja säilytykseen siirtämistä telttakankaan tulee olla täysin puhdas ja kuiva. Taita kangas kokoon saumoja pitkin. Tolppia ja vaarvoja ei saa säilyttää samassa pakkauksessa telttakankaan kanssa.
- Säilytä telttakangasta kuivassa paikassa, jossa on hyvä ilmanvaihto.

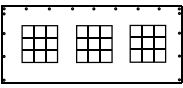
| | | | | | | | | |
|---|---|------|---|--|-------|---|---|------|
| ① |  | 8pcs | Ⓒ |  | 8pcs | Ⓖ |  | 1pc |
| ② |  | 9pcs | ⒫ |  M6*10 | 42pcs | Ⓕ |  | 1pc |
| ③ |  | 4pcs | ⒫ |  M6*45 | 8pcs | Ⓖ |  | 1pc |
| ④ |  | 4pcs | Ⓓ |  | 50pcs | Ⓖ |  | 1pc |
| Ⓐ |  | 6pcs | Ⓔ |  | 4pcs | Ⓖ |  | 1pc |
| Ⓑ |  | 6pcs | Ⓕ |  | 20pcs | Ⓖ |  | 2pcs |

STEP 1

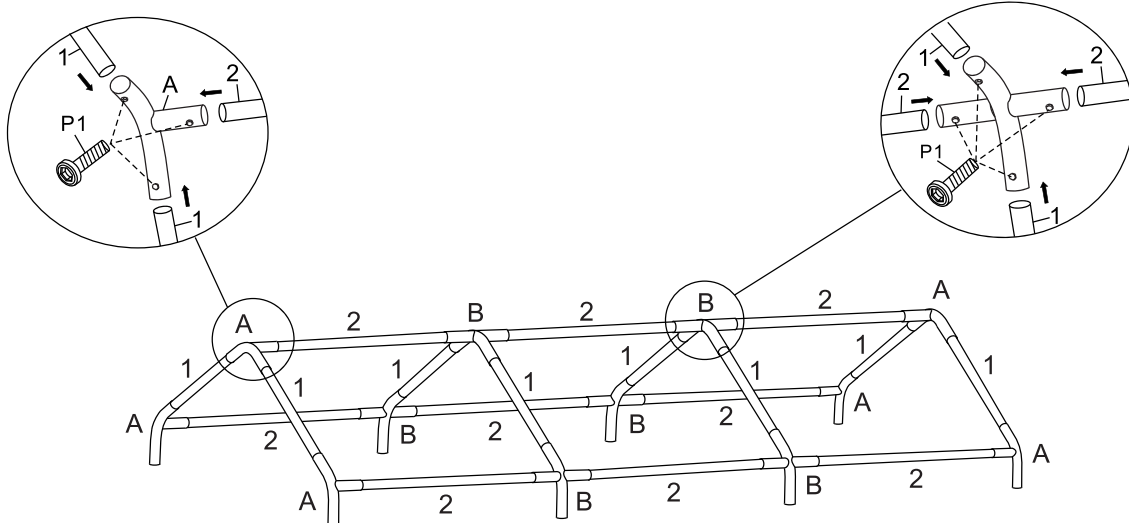

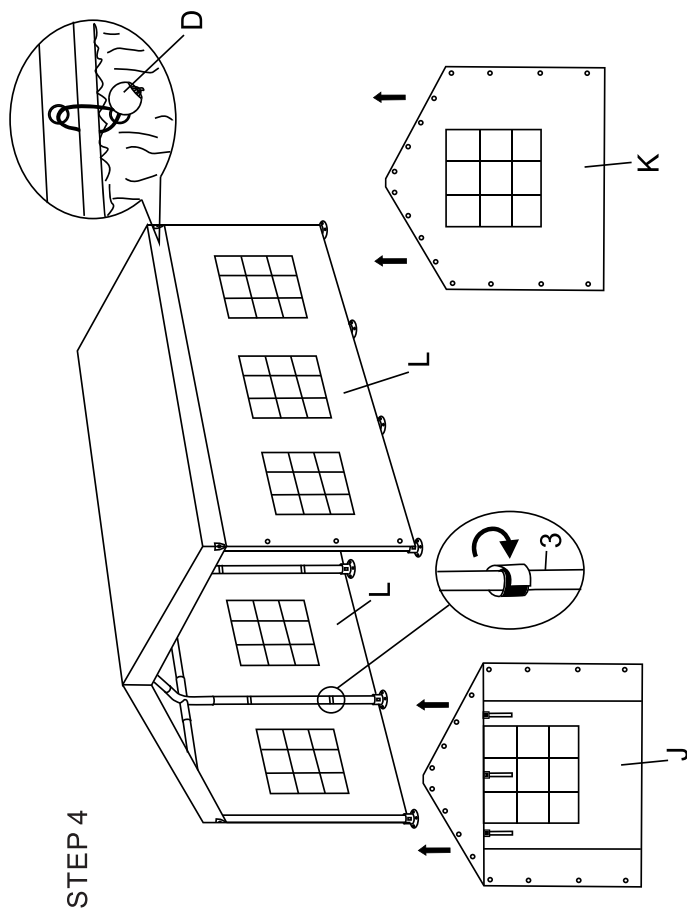
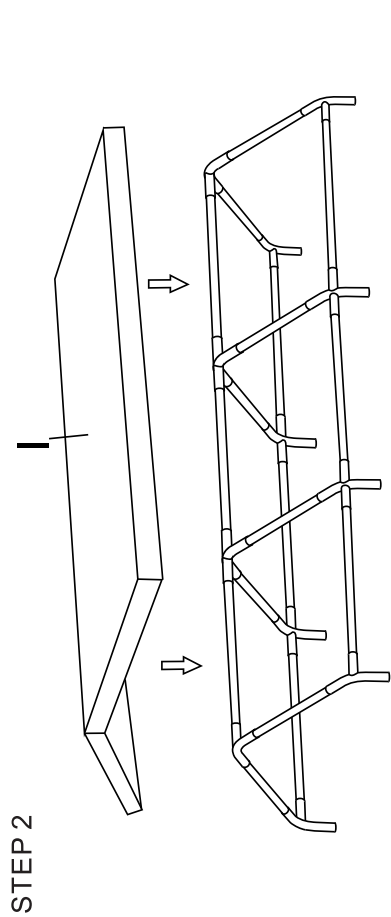
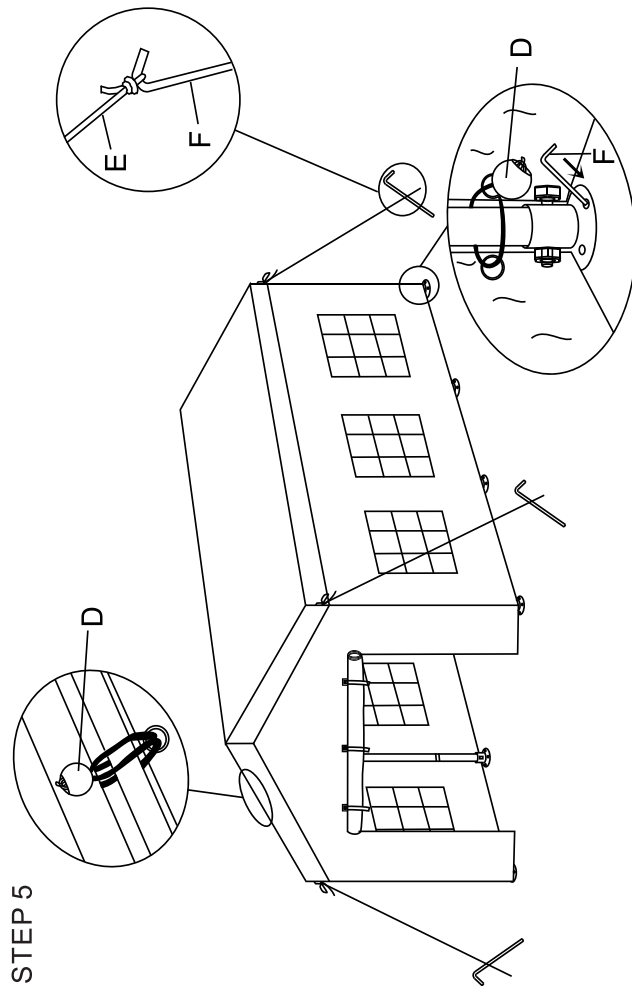
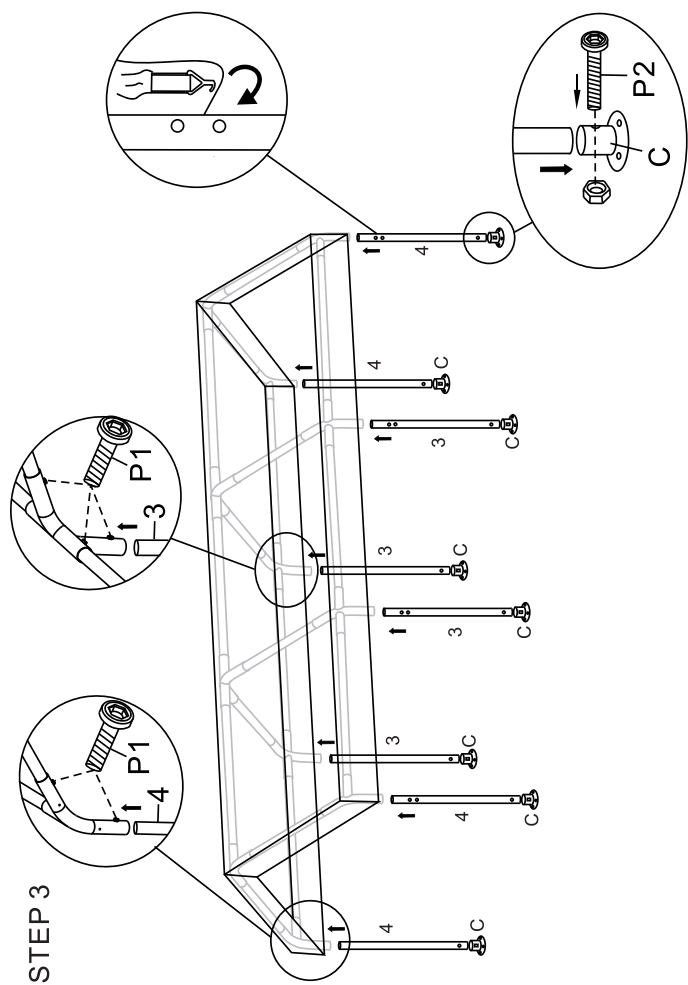

PARTYTELT 3 X 6 m

Læs og følg omhyggeligt instruktionerne nedenfor. Gem disse til fremtidigt brug.

Der skal være mindst to personer til at montere partyteltet.













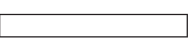

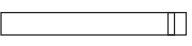
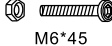
OBS! Der må ikke være børn i nærheden, når teltet opstilles. Opbevar teltets dele udenfor børns rækkevidde.

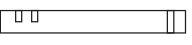
ADVARSEL!

- Tag teltet ned, før det begynder at blæse for meget.
- Lav aldrig åben ild i eller i nærheden af teltet.
- Eventuel sne, som samles på tagdugen, skal hurtigst muligt fjernes.

VEDLIGEHOLDELSE OG OPBEVARING

- Partyteltet er i første omgang beregnet til at beskytte mod solens stråler, ikke mod hård blæst og regn. Tagdugen med PVC-belægning er vandafvisende, men ikke vandtæt. For at materialet ikke skal ældes for hurtigt, skal du altid fjerne regnvand, som samles på dugen.
- Rengør tagdugen med et let rengøringsmiddel, og lad det derefter tørre helt. **OBS!** Brug aldrig opløsningsmidler, da disse kan blege og beskadige materialet. Brug heller ikke basiske eller sure rengøringsmidler. Rengør ikke dugen med højtrykspuler.
- Inden teltet tages ned, skal tagdugen være helt ren og tør. Læg det sammen langs med sømmene. Stænger og jordspyd må ikke pakkes sammen med dugen.
- Opbevar tagdugen et tørt og godt ventileret sted.

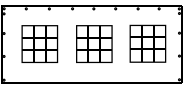
| | | | | | | | | |
|---|---|------|---|--|-------|---|---|------|
| ① |  | 8pcs | Ⓒ |  | 8pcs | Ⓖ |  | 1pc |
| ② |  | 9pcs | ⒫ |  M6*10 | 42pcs | Ⓕ |  | 1pc |
| ③ |  | 4pcs | ⒫ |  M6*45 | 8pcs | Ⓖ |  | 1pc |
| ④ |  | 4pcs | Ⓓ |  | 50pcs | Ⓖ |  | 1pc |
| Ⓐ |  | 6pcs | Ⓔ |  | 4pcs | Ⓖ |  | 1pc |
| Ⓑ |  | 6pcs | Ⓕ |  | 20pcs | Ⓖ |  | 2pcs |

STEP 1

