

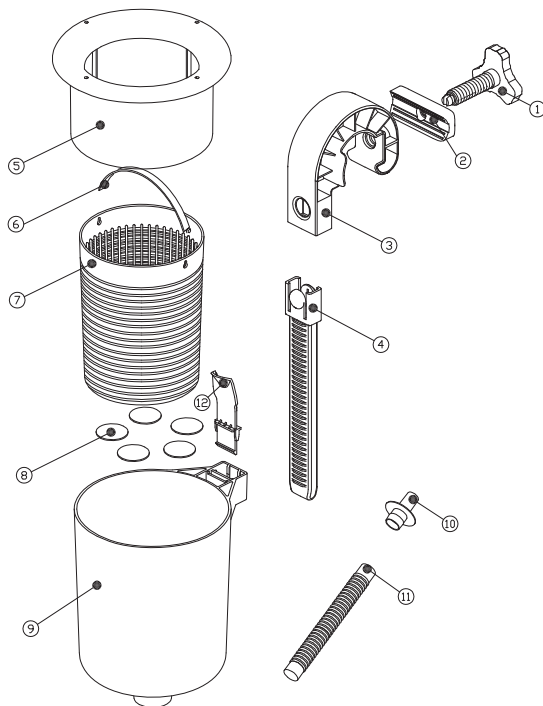











**BREDDAVLOPP/SKIMMER
PSRØR/SKIMMER
UIMA-ALTAAN PINTAKAIVO
BREDDEAFLØB/SKIMMER**



No.	Part Name	Quantity
1		1
2		1
3		1
4		1
5		1
6		1
7		1
8		5
9		1
10		1
11		1
12		1

